

# THW

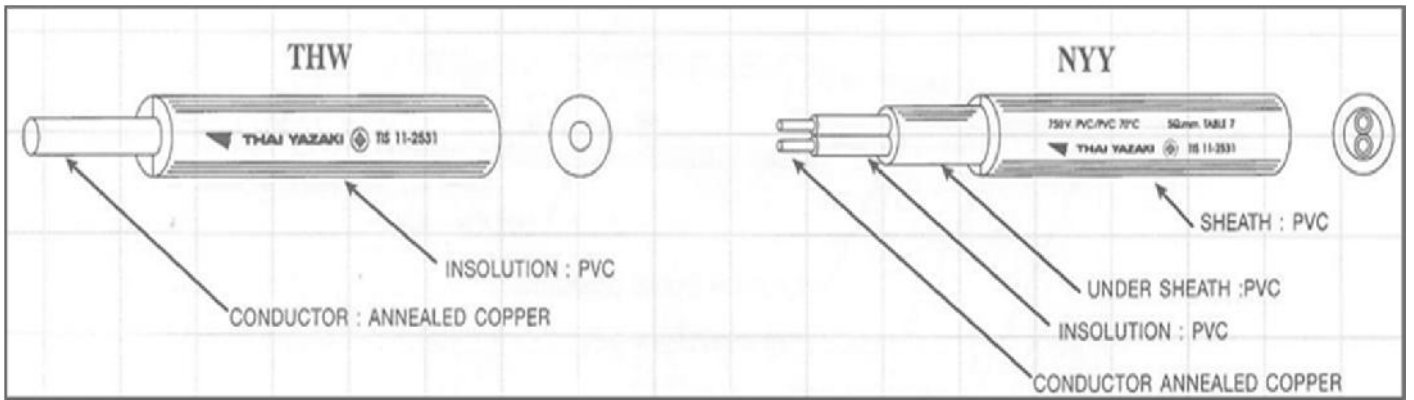

## THW

750 V 70° C SINGLE CORE PVC INSULATED STANDARD TIS 11-2531

สายกลมแกนเดี่ยวหุ้มด้วยฉนวน พีวีซี แรงดัน **750** โวลต์ อลูมิเนียม **70** องศาเซลเซียส  
ตามมาตรฐาน มอก. **11-2531**

## NYY

750 V 70° C PVC INSULATED, PVC SHEATHED STANDARD TIS 11-2531

สายส่งกำลังไฟชนิดกลุ่มใช้ฝังใต้ดิน หุ้มด้วยฉนวนและเปลือกนอก พีวีซี แรงดัน **750** โวลต์ อลูมิเนียม **70** องศา  
ตามมาตรฐาน มอก. **11-2531**

Sectional Area (mm) ขนาดพื้นที่หน้าตัด (ตร.มม.)	Price (Baht / Meter) ราคา (บาทต่อเมตร), ยี่ห้อ YAZAKI / MCI-DRAKA				
	THW		NYY		
	Number Of Core จำนวนแกน				
	1C	1C	2C	3C	4C
1	5.80	22.50	43.40	48.95	55.75
1.5	8.20	25.00	48.10	54.90	63.30
2.5	12.10	29.20	57.60	67.40	78.80
4	18.70	39.40	81.50	96.95	116.60
6 (7st)	30.00	58.80	112.90	140.00	170.50
10 (7st)	49.30	70.50	159.80	205.00	260.20
16	76.50	98.80	226.20	301.00	392.30
25	120.00	144.60	332.60	460.10	590.40
35 (19st)	170.50	196.00	441.10	622.30	859.00
50	229.20	259.70	630.30	874.70	1115.00
70	327.70	352.80	891.00	1183.70	1550.00
95	451.50	474.00	1200.00	1656.90	2155.00
120	572.00	608.00	1490.00	2092.00	2726.00
150	700.00	746.00	1830.00	2546.00	3338.00
185	879.00	928.00	2288.00	3170.00	4189.00
240 (61st)	1153.00	1209.00	2992.00	4145.00	5519.00
300	1445.00	1507.00	3724.00	5136.00	6850.00
400	1850.00	1928.00	-	-	-
500	2395.00	2527.00	-	-	-

# CV

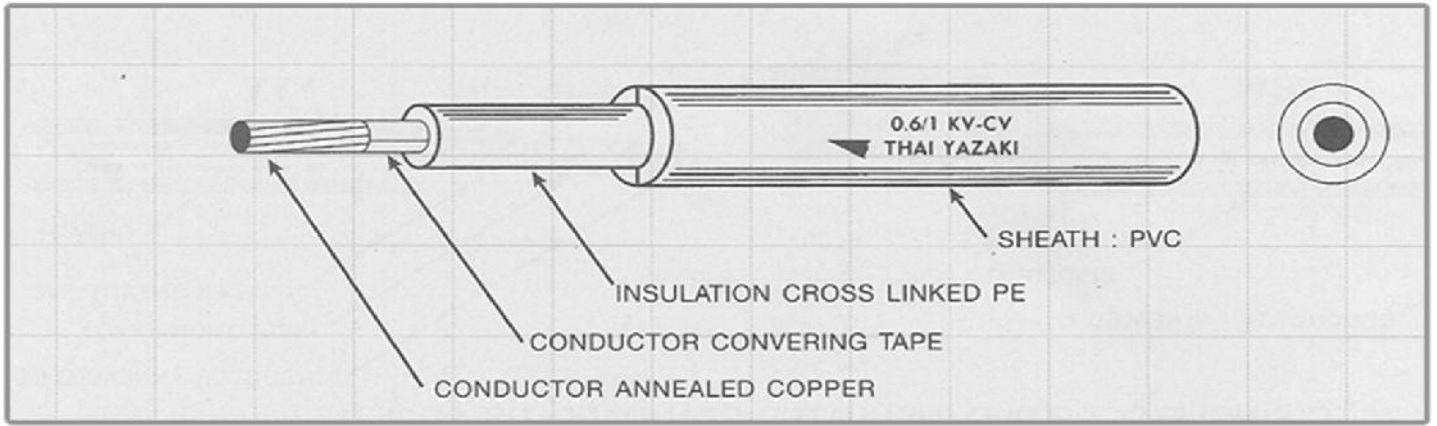

## CV

1000 V 90 °C Cross - Linked polyethylene Insulated and PVC Sheathed Power cable. IEC 60502

### REFERENCES

1. Conductor
2. Extruded
3. XLPE Insulation
4. Extruded
5. Copper Shield
6. Separator Tape
7. PVC Jacket

Sectional Area (mm) ขนาดพื้นที่หน้าตัด (ตร.มม.)	Price (Baht / Meter) ราคา (บาทต่อเมตร) , ยี่ห้อ YAZAKI / MCI-DRAKA			
	0.6/1 KV-CV			
	Number Of Core จำนวนแกน			
	1C	2C	3C	4C
2.5	24.95	56.5	70.65	87.2
4	31.45	71.5	92	114.7
6	41.3	93.8	122	153
10	54.5	120	165	224
16	81	185	252	330
25	123.5	295	400	523
35	170	397	540	707
50	234.5	530	728	965
70	329	736	1,029.00	1,360.00
95	453	1,012.00	1,405.00	1,870.00
120	575	1,277.00	1,790.00	2,380.00
150	704	1,566.00	2,200.00	2,930.00
185	882	1,952.00	2,770.00	3,700.00
240	1,156.00	2,555.00	3,620.00	4,850.00
300	1,460.00	3,193.00	4,520.00	6,310.00
400	1,870.00	4,068.00	5,900.00	7,970.00
500	2,500.00	-	-	-
630	3,200.00	-	-	-
800	4,005.00	-	-	-
1,000	5,285.00	-	-	-

# CVV-F, CVV-S

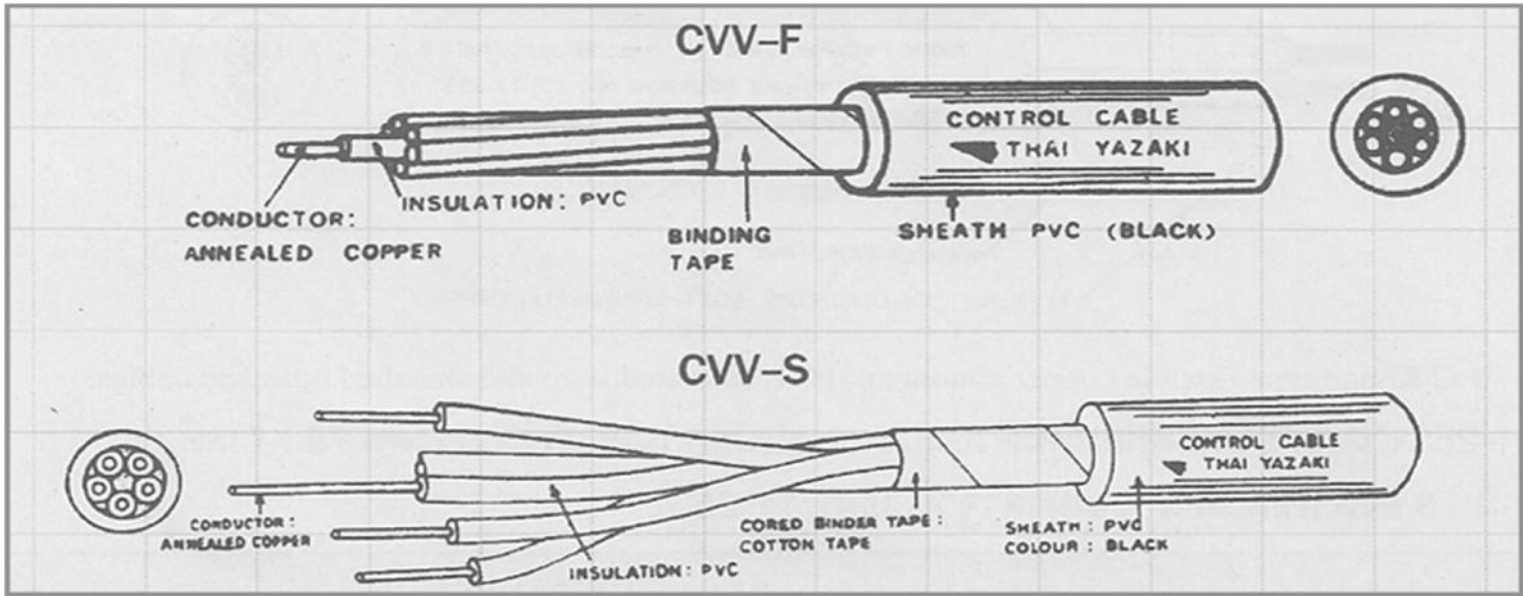

## CVV-F

600 V 70° C PVC INSULATED AND SHEATHED CONTROL CABLE

... 600 70° C

## CVV-S

600 V 70° C PVC INSULATED AND SHEATHED CONTROL CABLE WITH SHIELD

... 600 70° C

No. of Core	บริษัท YAZAKI / MCI-DRAKA									
	CVV-F					CVV-S				
	0.75	1	1.5	2.5	4	0.75	1	1.5	2.5	4
2	34.30	36.50	40.30	54.50	74.80	62.80	65.65	73.20	91.30	121.20
3	38.10	41.90	49.30	68.80	94.30	68.80	74.80	83.70	109.00	145.60
4	47.80	49.40	59.80	85.30	125.60	80.60	85.30	98.80	130.00	176.40
5	58.30	65.00	76.20	109.20	152.50	94.30	101.70	116.60	158.60	209.30
7	68.80	78.50	94.30	137.80	198.90	109.20	119.60	141.70	191.10	262.60
9	91.30	106.20	129.40	183.80	263.20	133.90	147.90	171.60	239.20	326.30
10	98.70	114.40	140.40	201.80	290.00	146.90	159.90	187.20	261.30	366.60
12	109.90	128.60	158.50	233.20	342.20	158.60	174.20	209.30	291.20	406.90
14	121.80	140.50	176.40	261.60	386.10	174.20	195.00	230.10	322.40	475.80
16	130.80	153.90	195.00	292.50	445.90	187.20	211.90	254.80	361.40	533.00
19	148.70	175.80	224.50	341.90	517.40	209.30	239.20	283.40	416.00	598.00
21	167.70	198.90	250.90	379.60	572.00	228.80	258.70	309.40	470.60	676.00
24	185.90	219.70	280.80	439.40	647.40	254.80	289.90	349.70	530.40	773.50
27	206.70	239.20	312.40	484.40	722.20	278.20	313.30	383.50	581.10	847.60
30	221.00	261.30	341.90	531.70	795.60	295.10	339.30	425.10	633.10	926.90

VCT

VCT

750 V 70 C Round type flexible copper conductor, PVC insulated wire and sheathed wire and cables.

TIS 11-2531

750

70

.11-2531

No. of Core	ยี่ห้อ YAZAKI / MCI-DRAKA		ยี่ห้อ FUHRER	
	Cross Sectional Area(mm) ขนาดพื้นที่หน้าตัด (ด . .)	Price (Baht / Meter) ( )		
2	0.5	19.70	12.85	
	0.75	22.30	14.60	
	1	26.10	17.00	
	1.5	34.60	22.60	
	2.5	55.70	36.40	
	4	79.50	52.00	
	6	112.90	72.95	
	10	195.30	127.70	
	16	280.00	183.10	
	25	441.50	274.80	
	35	585.10	364.60	
	0.5	22.90	14.90	
	0.75	27.90	18.30	
	1	35.40	23.10	
3	1.5	43.90	28.70	
	2.5	79.40	51.90	
	4	100.40	65.60	
	6	146.90	96.10	
	10	256.30	167.60	
	16	379.00	243.50	
	25	571.00	365.00	
	35	798.00	490.00	
	0.5	29.00	18.90	
	0.75	37.10	24.20	
4	1	44.10	28.90	
	1.5	56.80	37.10	
	2.5	88.70	58.00	
	4	127.50	83.40	
	6	191.20	125.00	
	10	335.30	219.40	
	16	485.40	313.60	
	25	731.40	469.40	
	35	1018.00	633.50	

VAF,VTF,VFF

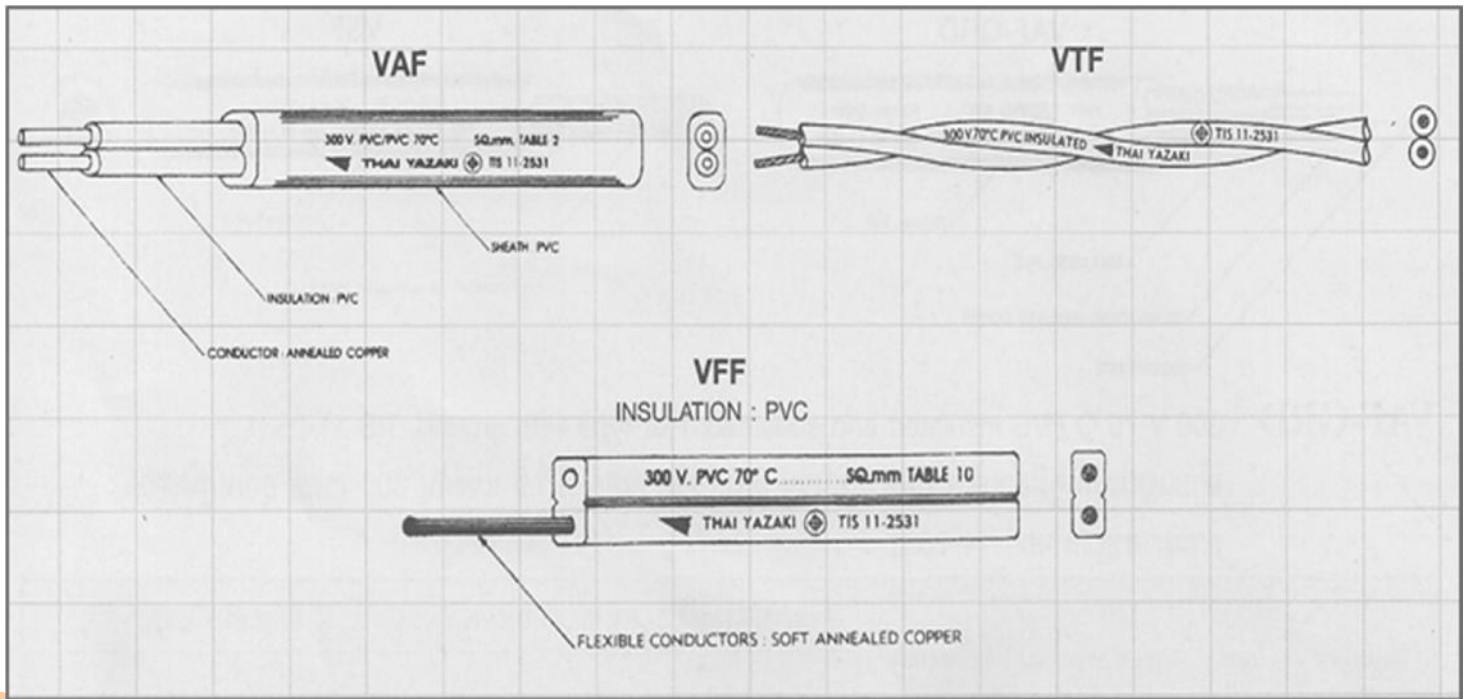

**VAF**      300 V 70° C Flat PVC insulated and, PVC sheathed, Standard TIS 11-2531  
 . . . . . 300      70°C  
 .11-2531

**VTF**      300 V 70° C PVC insulated twisted, flexible conductor Standard TIS 11-2531  
 .11-2531

**VFF**      300 V 70° C Flat twin flexible PVC insulated Standard TIS 11-2531  
 . . . . . 300      70° C  
 .11-2531

No. of Core	Cross Sectional Area(mm) ขนาดพื้นที่หน้าตัด (ด . . .)	ยี่ห้อ THAI YAZAKI, MCI - DRAKA ,      ยี่ห้อ FUHRER			
		Price (Baht / Meter)      (      )			
		VAF	VTF	VFF	VAF
2	0.5	6.80	-	6.9	-
	0.75	-	-	9.7	-
	1	11.6	15.7	11.8	8.83
	1.5	16.75	19.6	15.7	12.36
	2.5	27.05	30.3	23.8	19.87
	4	41.9	-	-	31.62
	6	66.7	-	-	51.71
	10	107.85	-	-	81.37
	16	167.15	-	-	124.68

## VAF/G,VSF

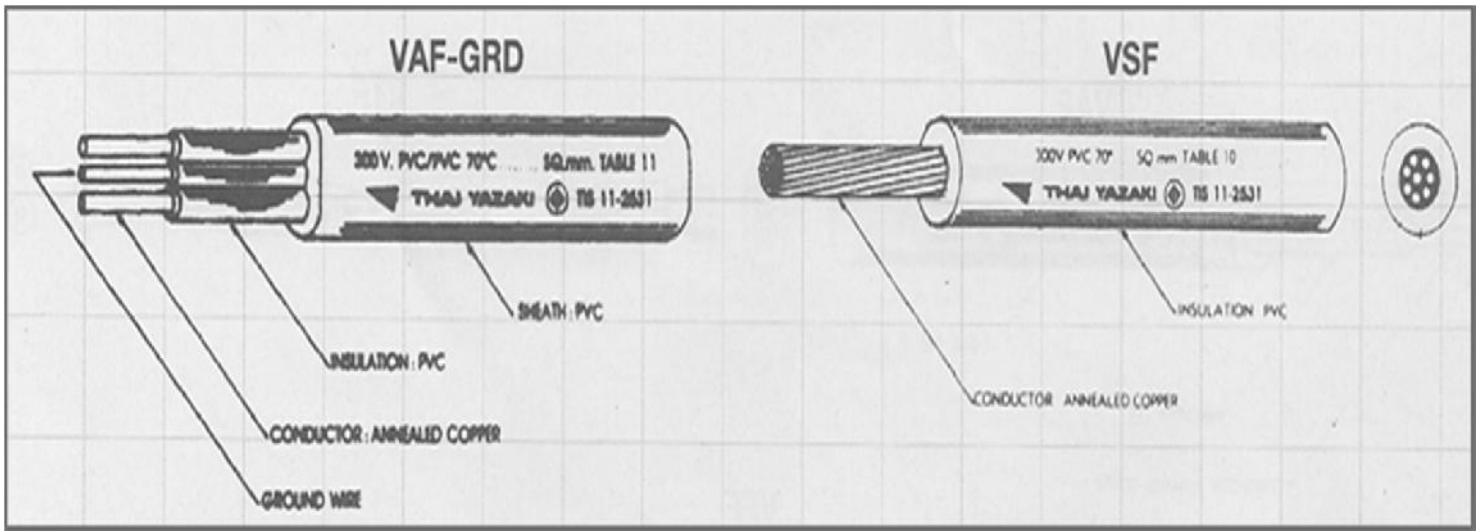

### VAF-GRD

300 V 70° C PVC insulated and sheathed, Flat type with ground, TIS 11-2531

300 โวลต์ ฉนวนหุ้ม 70°C

.11-2531

No. of Core	ยี่ห้อ YAZAKI / MCI-DRAKA		ยี่ห้อ FUHRER	
	Cross Sectional Area(mm) ขนาดพื้นที่หน้าตัด (ต . .)	Price (Baht / Meter) ( . . )		
2	1 / 1	23.40	-	
	1.5 / 1	30.5	22.9	
	2.5 / 1.5	42	31.6	
	4 / 2.5	62.3	45.5	
	6 / 6	100.9	64	
	10 / 4	139	88.3	
	16 / 6	209	133	
	25 / 6	312	-	
	35 / 10	447	-	

### VSF

300 - 600 V 70° C PVC insulated flexible conductor Standard TIS 11-2531

.11-2531

No. of Core	ยี่ห้อ YAZAKI / MCI-DRAKA		ยี่ห้อ FUHRER	
	Cross Sectional Area(mm) ขนาดพื้นที่หน้าตัด (ต . .)	Price (Baht / Meter) ( . . )		
1	0.5	4.90	3.18	
	0.75	6	3.94	
	1	7.30	4.76	
	1.5	9.50	6.20	
	2.5	14.40	9.40	
	4	21.58	17.30	
	6	37.30	27	
	10	59.76	43.60	
	16	85.69	67.50	
	25	129.91	99.70	
	35	-	149	
	50	-	210	

NYY-G , VCT-G

**NYY-GRD**

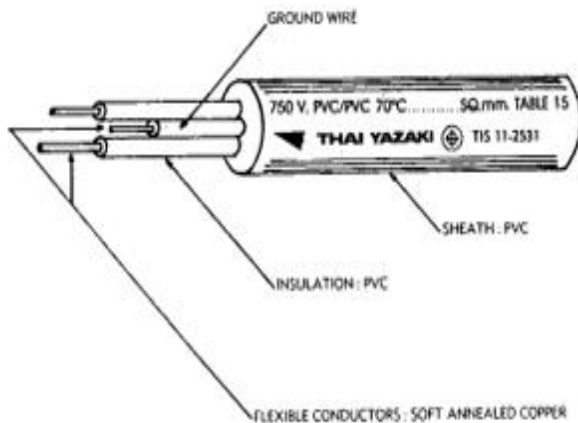

**VCT-GRD**

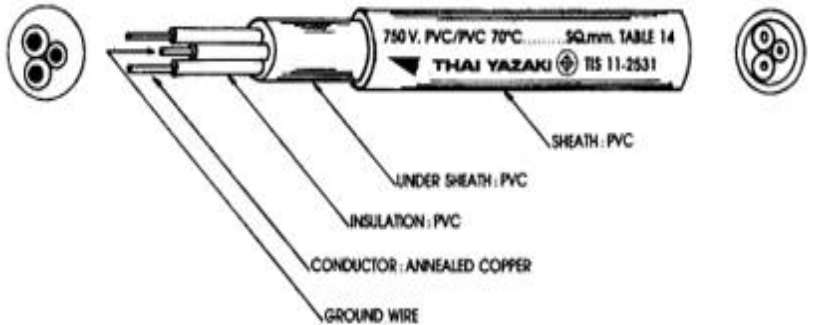

**NYE-GRD**

750 V 70° C PVC INSULATED AND DOUBLE SHEATHED ROUND TYPE, WITH GROUND

**VCT-GRD**

750 V 70° C PVC INSULATED AND SHEATHED FLEXIBLE CONDUCTOR WITH GROUND

Cross Sectional Area(mm) ขนาดพื้นที่หน้าตัด ( . . )	Price (Bath/Meter) ( / ). ยี่ห้อ YAZAKI					
	NYE-GRD			VCT-GRD		
	2 C	3 C	4 C	2 C	3 C	4 C
1 / 1	58.3	67.1	71.67	39	48.5	64
1.5 / 1	66	75.9	86.77	46	60	77
2.5 / 1.5	81.4	96.42	120.21	83.3	94	112
4 / 2.5	110.79	141.89	177.28	102	128	172
6 / 4	160.6	206.11	259.06	150	202	292
10 / 4	233.2	300.71	389.15	243	320	438
16 / 6	336.96	456.03	580.37	360	465	625
25 / 6	510.4	673.67	859.47	640	700	910
35 / 10	697.3	946	1,226.04	750	970	1,275.00
50/10	895.18	1,229.68	1,580.39	-	-	-
70/10	1,211.51	1,675.66	2,184.57	-	-	-
95/16	1,657.82	2,305.88	3,012.99	-	-	-
120/16	2,056.03	2,880.97	3,754.54	-	-	-
150/25	2,543.59	3,553.17	4,619.57	-	-	-
185/25	3,133.98	4,391.13	5,741.53	-	-	-
240/35	4,112.99	5,770.08	7,494.04	-	-	-
300/35	5,067.80	7,117.18	9,343.59	-	-	-

## Thw-A ,

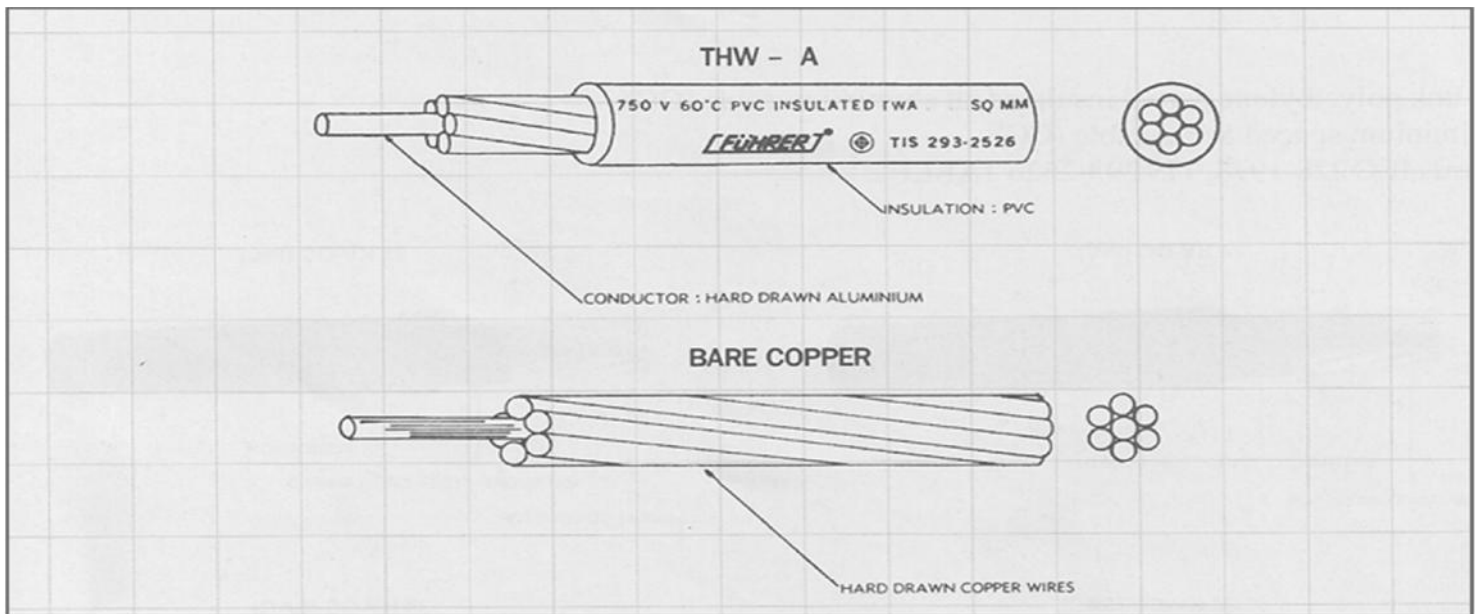

### THW-A

750 V 75 °C PVC Insulated Aluminum Conductor Single Core

### BARE COPPER

Hard Drawn Copper Stranded Conductor

No. of Core	THW-A	BARE COPPER
	Price (Baht / Meter) ( )	Price (Baht / Meter) ( )
6	-	30
10	7.15	49.30
16	10.20	76.50
25	15	120
35	19.50	170.50
50	29.97	229.20
70	36.44	327.70
95	48.15	451.50
120	59.03	572
150	81.44	700
185	100.75	879
240	130	1,153.00



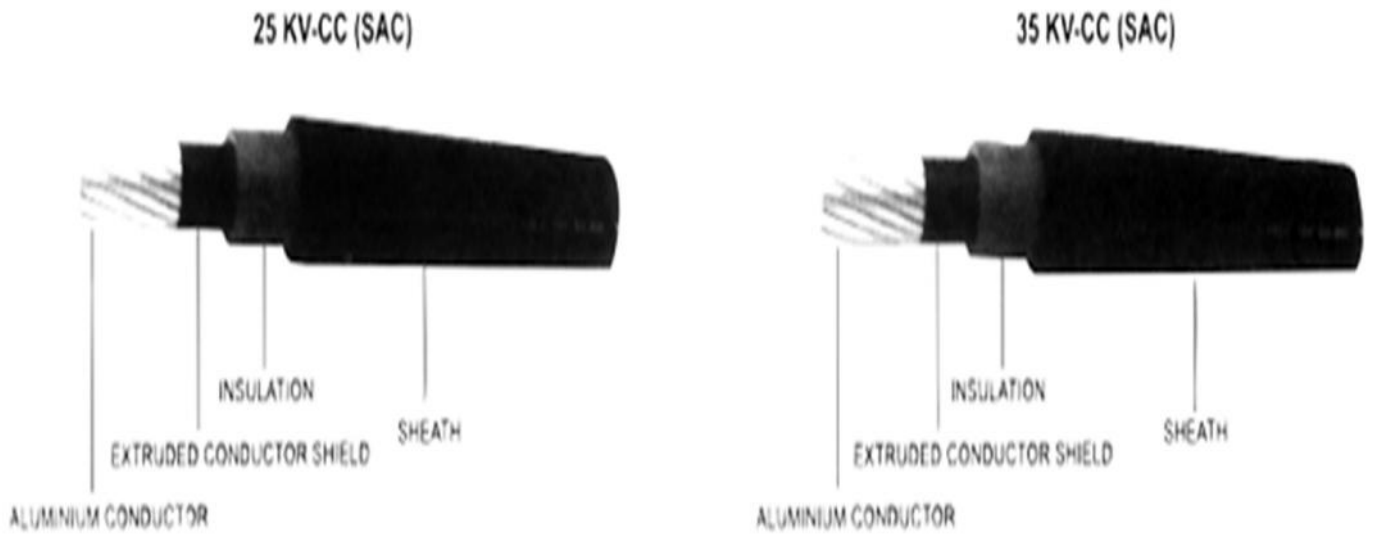

Cross-link polyethylene partial insulated all aluminium cable (OC)

All aluminum spaced aerial cable (CC)

Standard : IEC 228-1978, TIS 293-2526 TABLE 2

พื้นที่หน้าตัด (ตร. มม.) Cross Sectional	Price (Baht / Meter) ( )	
	25 KV-CC (SAC)	35 KV-CC (SAC)
35	188	-
50	199	224
70	245	270
95	274	301
120	323	355
150	355	390
185	369	408
240	448	492

# XLPE

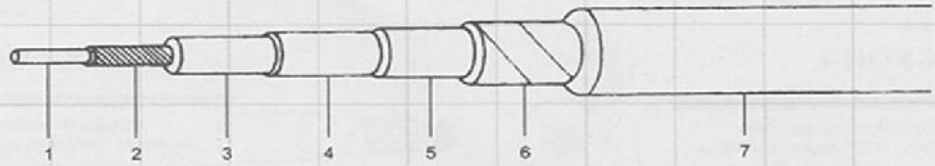

## REFERENCES

- |                               |                       |
|-------------------------------|-----------------------|
| 1. Conductor                  | 5. Copper Shield Tape |
| 2. Extruded Conductor Shield  | 6. Separator          |
| 3. XLPE Insulation            | 7. PVC Jacket         |
| 4. Extruded Insulation Shield |                       |

## XLPE

CU XLPE insulated, PVC Jacketed power cable standard IEC 502

สายตัวนำทองแดง หุ้มด้วยฉนวนครอสลิง พิอี พันหยาทองแดง และเปลือกนอก พีวีซี

- |                    |                     |
|--------------------|---------------------|
| 1. 8/3 (3.6 KV) CV | 8.7/15 (17.5 KV) CV |
| 3. 6/6 (7.2 KV) CV | 12/20 (24 KV) CV    |
| 6/10 (12 KV) CV    | 18/30 (36 KV) CV    |

Cross Sectional Area(mm) ขนาดพื้นที่หน้าตัด ( . . )	Price (Bath/Meter) ( / )					
	1.8/3 (3.6 KV) CV		3.6/3 (7.2 KV) CV		6/10 (12 KV) CV	
	1C	3C	1C	3C	1C	3C
10	126.70	336.60	159	498	-	-
16	161	443.50	198	608	246	762
25	210	592.70	245	766	269	929
35	257.40	740.50	299	927	351	1,102.00
50	320.80	955.70	365	1,156.00	423	1,334.00
70	425	1,268.00	465	1,468.00	528	1,676.00
95	553	1,669.00	591	1,873.00	659	2,102.00
120	686	2,075.00	718	2,276.00	789	2,501.00
150	826	2,514.00	866	2,685.00	927	2,915.00
185	1,012.00	3,094.00	1,057.00	3,218.00	1,119.00	3,545.00
240	1,298.00	3,970.00	1,359.00	4,118.00	1,428.70	4,503.00
300	1,598.00	4,904.00	1,672.00	5,060.00	1,747.00	5,490.00
400	2,004.00	6,152.00	2,097.00	6,466.00	2,187.00	6,847.00
500	2,535.00	-	2,653.00	-	-	-

Cross Sectional Area(mm) ขนาดพื้นที่หน้าตัด ( . . )	Price (Bath/Meter) ( / )					
	8.7/15 (17.5) KV-CV		12/20 (24) KV-CV		18/30 (36) KV-CV	
	1C	3C	1C	3C	1C	3C
25	338	1,079.00	-	-	-	-
35	397	1,258.00	438	1,408.00	602	1,981.00
50	467	1,512.00	515	1,652.00	633	2,097.00
70	577	1,847.00	620	1,996.00	746	2,504.00
95	711	2,271.00	757	2,474.00	889	2,952.00
120	844	2,795.00	896	2,898.00	1,026.00	3,410.00
150	977	3,166.00	1,028.00	3,331.00	1,174.00	3,856.00
185	1,164.00	3,715.00	1,209.00	3,938.00	1,362.00	4,438.00
240	1,478.00	4,649.00	1,515.00	5,051.00	1,656.00	5,573.00
300	1,797.00	5,747.00	1,843.00	5,957.00	1,953.00	6,648.00
400	2,241.00	7,000.00	2,287.00	7,224.00	2,410.00	7,961.00

MAX-FOH      MAX-FOH i

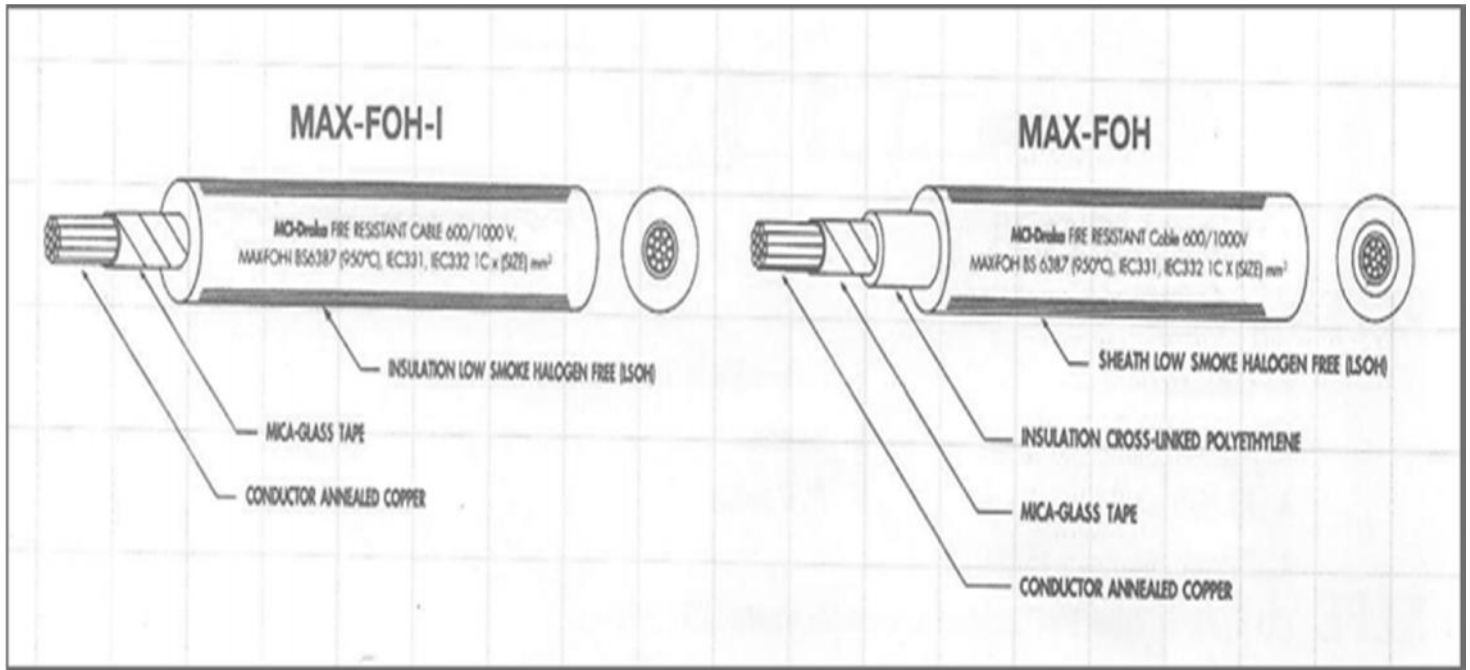

**MAX-FOH**

Fire resistant cable 950°C hrs., plain annealed copper conductor Mica tape lapping XLPE insulated.

Low smoke halogen free polymer, Flame retardant sheathed cable complying with BS 6387 Cat. CWZ IEC 331, IEC 332-3, IEC 502

IEC 754, IEC 1034, 600 / 1000 V.

สายไฟฟ้าประเภททนไฟที่ 950°C      3      .

Mica หุ้มทั้งฉนวนด้วยครอส

BS 6387 Cat. CWZ IEC 331, IEC 332-3, IEC 502, IEC 754, IEC 1034, 600 / 1000 V.

Cross Sectional Area(mm) ขนาดพื้นที่หน้าตัด (ต . . .)	Price (Baht / Meter) (      )				
	MAX-FOH-I	MAX-FOH			
	Number Of Core จำนวนแกน				
	1	1	2	3	4
1.5					
2.5					
4					
6					
10					
6					
25					
35					
50					
70					
95					
120					
150					
185					
240					
300					
400					

: 099-294-2888 , 093-789-5536 , 062-289-8936

# UTP CAT5e CAT6



Generic Cabling  
UTP Cat 5E 125 MHz

- 4x2/0.5mm PVC
- 4x2/0.5mm PE
- 4x2/0.5mm LSOH

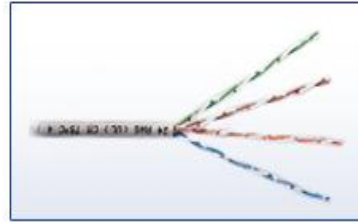

UTP (Unscreened Twisted Pair) for use as horizontal cable in generic cabling systems. The UTP cable has solid copper conductors insulated with PE. The cable is supplied with PVC, PE (UV stabilised) or LSOH Jacket. All cables are approved in accordance with the most stringent test procedures. They are also 3P and ETL verified in accordance with the following standards : ISO/IEC 11801, EIS/TIA 568B.2 and EN 50173. UL Verification and CM/CMR Listing version is available.

## Cable Construction

Number of Pairs	Sheath	Conductor Dimension (mm)	Insulation Diameter (mm)	Insulation Color	Cable Diameter (mm)	Weight (kb/km)
4	PVC PE LSOH	0.5	0.9 PE	BLUE/White-Blue ORANGE/White-Orange GREEN/White-Green BROWN/White-Brown	4.8	28

## Cable Properties

Blendind		Fire classification	
Minimum bending radius installed	4 x D	PVC	IEC 60332-1, UL CM, UL CMR
Tensile strength		LSOH	IEC61034, IEC60754, IEC60332-1
Maximum tensile load, installation	100 N		
Maximum tensile load, installed	No stretch		
Temperature window		Operation Voltage	
Operation	-20°C to +60°C	Normal	30V DC
Installation	0°C to + 50°C	Maximum	72V DC

### TPEV ภายใน



### AP ภายนอกไม่มีสลิง



### TIEV ภายใน

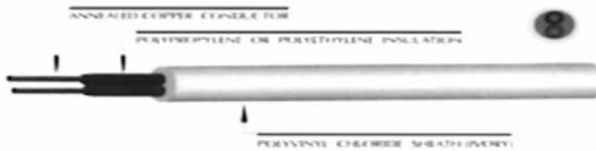

### FIG-8 ภายนอกมีสลิง

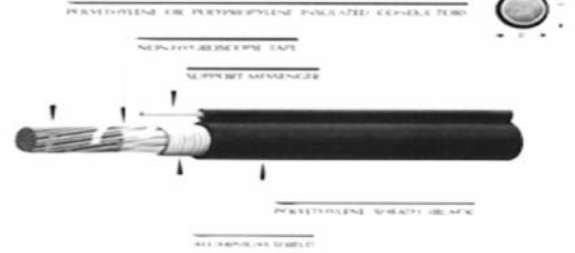

### NYY-GRD

750 V 70° C PVC INSULATED AND DOUBLE SHEATHED ROUND TYPE, WITH GROUND

### VCT-GRD

750 V 70° C PVC INSULATED AND SHEATHED FLEXIBLE CONDUCTOR WITH GROUND

(TPEV)			(AP-Fig8)		(AP)	
No. (Pairs)	24 IN 0.5 mm	22 IN 0.65 mm	24 FA 0.5 mm	22 FA 0.65 mm	24 EA 0.5 mm	22EA 0.65 mm
4P	19	26	-	-	-	-
5P	22	31	-	-	-	-
6P	25	35	96	114	45	58
8P	33	48	-	-	-	-
10P	37	55	114	140	62	79
15P	54	81	136	172	79	107
20P	68	104	158	198	92	132
25P	83	128	172	225	110	152
30P	104	155	194	260	132	180
40P	140	205	-	-	-	-
50P	160	250	268	375	185	272
100P	310	480	448	665	355	525
150P	-	-	630	965	500	785
200P	600	945	845	1,275.00	675	1,030.00

Station - Wire (TIEV) No.	24 AWG 0.5 mm	22 AWG 0.65 mm
2 C	3.85	5.45
3 C	5.1	7.5
4 C	6.25	9.35
5 C	7.6	11.6
6 C	8.85	14